

Új RPT sorozat HF gyújtással

EASYFIT csatlakozóval

LTE-120H

Kompatibilis: LINCOLN® T100

LTE-120M

LTE-150H

Kompatibilis: CEBORA® P150 - CP160

LTE-150M

LTE-81H

Kompatibilis: TRAFIMET® A80 - Ergocut A81

LTE-81M

LTE-101H

Kompatibilis: TRAFIMET® A90 - Ergocut A101

LTE-101M

LTE-141H

Kompatibilis: TRAFIMET® A140 - Ergocut A141

LTE-141M

LTE-151H

Kompatibilis: TRAFIMET® A145 - Ergocut A151

LTE-151M

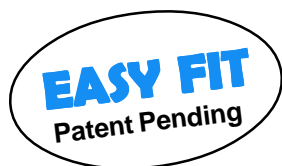

● **Jobb teljesítmény**

● **Tisztább vágás**

● **Gyorsabb munka**

EASY FIT

LTE-120H

LTE-120M

LTE-150H

LTE-150M

LTE-81H

LTE-81M

LTE-101H

LTE-101M

LTE-141H

LTE-141M

LTE-151H

LTE-151M

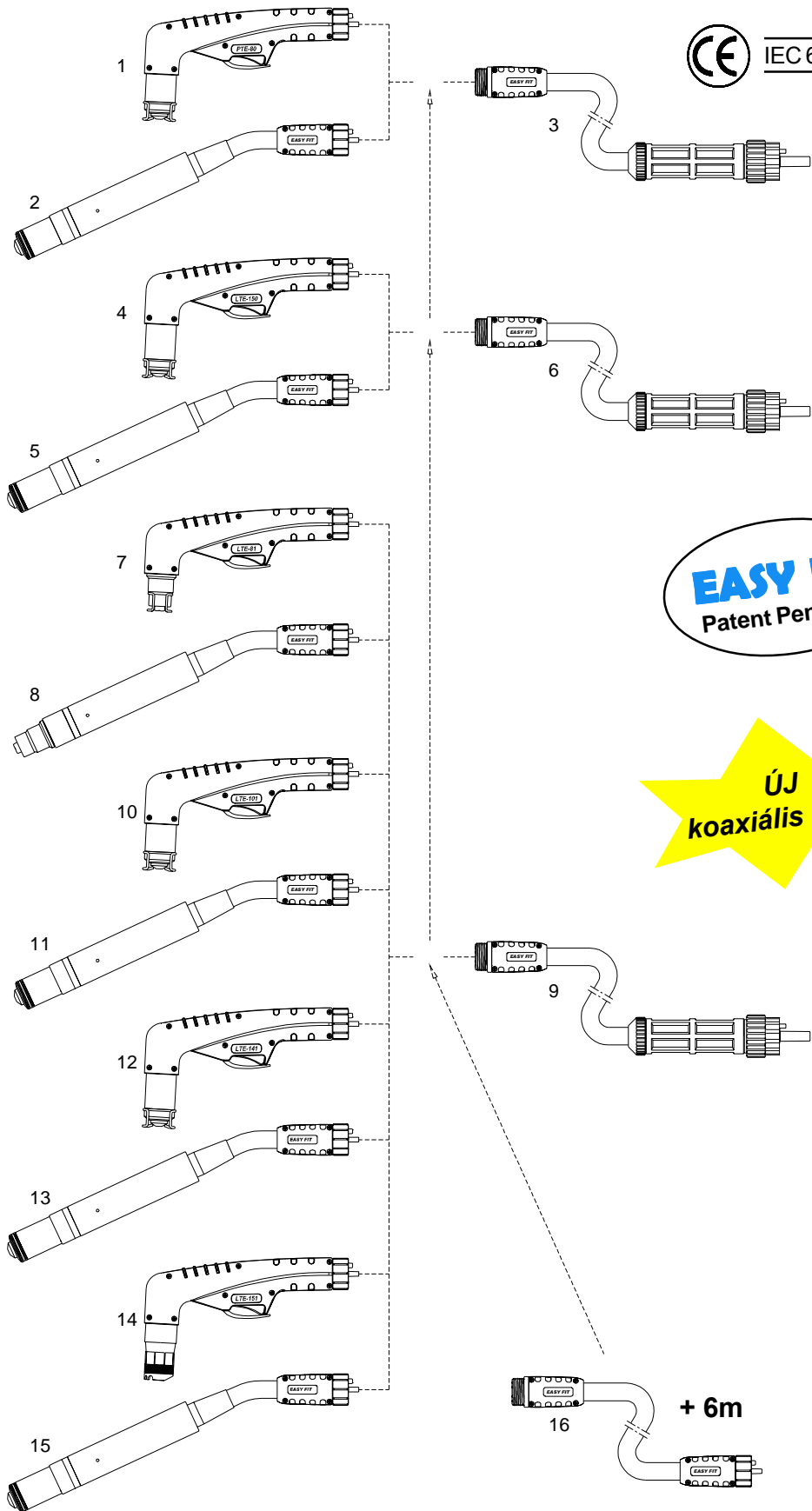

LTE-120 Suitable for: LINCOLN® T100

<i>item#</i>	<i>Catalog #</i>	<i>Description</i>
1	01201E	LTE-120H Hand torch head EASY FIT, w/ handle & parts.
2	01400E	LTE-120M Machine torch head EASY FIT, w/positioning tube & parts
3	09781FX	Lead Assembly, 6m (20 ft) EASY FIT, Coaxial Cable , (central connector)
16	05285FX	Extension , 6m (20 ft), complete with EASY FIT, Coaxial Cable

LTE-150 Suitable for: CEBORA® P150 - CP160

<i>item#</i>	<i>Catalog #</i>	<i>Description</i>
4	02001E	LTE-150H Hand torch head EASY FIT, w/ handle & parts.
5	04300E	LTE-150M Machine torch head EASY FIT, w/positioning tube & parts
6	09781FX-C	Lead Assembly, 6m (20 ft) EASY FIT, Coaxial Cable , (central connector)
16	05285FX	Extension , 6m (20 ft), complete with EASY FIT, Coaxial Cable

LTE-81 Suitable for: TRAFIMET® A80 - Ergocut A81

<i>item#</i>	<i>Catalog #</i>	<i>Description</i>
7	06802E	LTE-81H Hand torch head EASY FIT, w/ handle & parts.
8	06811E	LTE-81M Machine torch head EASY FIT, w/positioning tube & parts
9	09781FX-T	Lead Assembly, 6m (20 ft) EASY FIT, Coaxial Cable , (central connector)
16	05285FX	Extension , 6m (20 ft), complete with EASY FIT, Coaxial Cable

LTE-101 Suitable for: TRAFIMET® A90 - Ergocut 101

<i>item#</i>	<i>Catalog #</i>	<i>Description</i>
10	06001E	LTE-101H Hand torch head EASY FIT, w/ handle & parts.
11	06600E	LTE-101M Machine torch head EASY FIT, w/positioning tube & parts
9	09781FX-T	Lead Assembly, 6m (20 ft) EASY FIT, Coaxial Cable , (central connector)
16	05285FX	Extension , 6m (20 ft), complete with EASY FIT, Coaxial Cable

LTE-141 Suitable for: TRAFIMET® A140 - Ergocut 141

<i>item#</i>	<i>Catalog #</i>	<i>Description</i>
12	06201E	LTE-141H Hand torch head EASY FIT, w/ handle & parts.
13	06400E	LTE-141M Machine torch head EASY FIT, w/positioning tube & parts
9	09781FX-T	Lead Assembly, 6m (20 ft) EASY FIT, Coaxial Cable , (central connector)
16	05285FX	Extension , 6m (20 ft), complete with EASY FIT, Coaxial Cable

LTE-151 Suitable for: TRAFIMET® R145 - Ergocut A151

<i>item#</i>	<i>Catalog #</i>	<i>Description</i>
14	06901E	LTE-151H Hand torch head EASY FIT, w/ handle & parts.
15	06910E	LTE-151M Machine torch head EASY FIT, w/positioning tube & parts
9	09781FX-T	Lead Assembly, 6m (20 ft) EASY FIT, Coaxial Cable , (central connector)
16	05285FX	Extension , 6m (20 ft), complete with EASY FIT, Coaxial Cable

LTE-120H LTE-120M

Suitable for: LINCOLN® T100

Max Current : 100Amps
 Duty Cycle: 100 Amps - 60%
 Gas: Air
 Gas Pressure: 70 psi (4.5-5.0 bar)
 Gas Flow: 380 scfh (180 lpm)
 Post Flow Time: 90 sec. recommended
 Pilot : Electrode to Tip
 Ignition: HF

EASY FIT
Patent Pending

ÚJ
koaxiális kábel

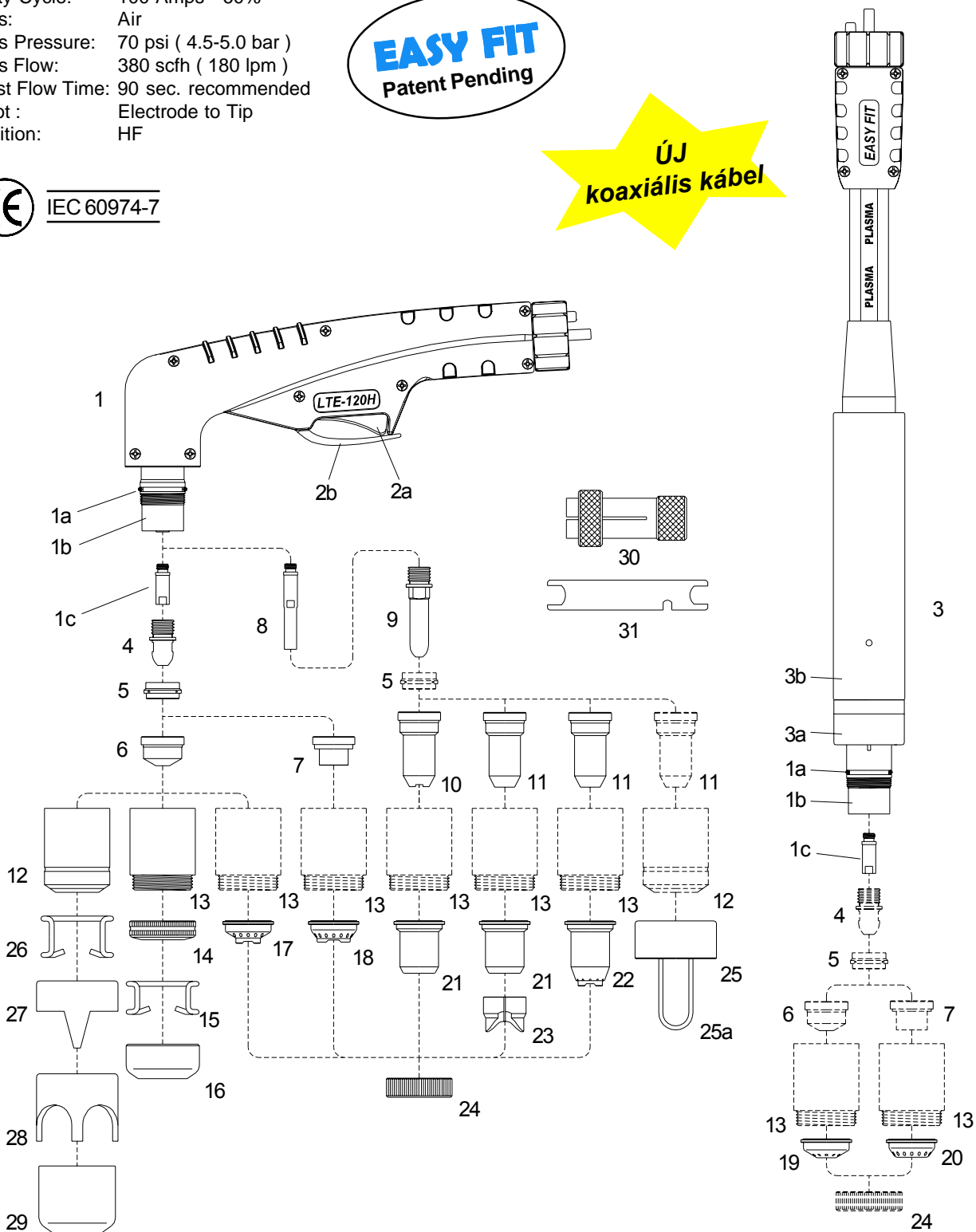

Standard Layout
 ○ Hand Torch
 □ Machine Torch

Replacement Parts Suitable for: LINCOLN® T100

Torch parts

Item#	ref.	Catalog #	Description
1	○	01201E	LTE-120H Hand torch head EASY FIT , w/ handle & parts.
1a	W0300121	02000.60	O - Ring
1b		60085	Front insulator
1c	W0300122	06004	Diffusor
2a	W0300103	07301.20	Switch
2b		09605.42	Safety Tab
3	□	01400E	LTE-120M Machine torch head EASY FIT , w/ positioning tube & parts.
3a		01400	Machine torch head
3b		03310	Positioning Tube
4	○ □	W0300123	Electrode
5	○ □	W0300124	Swirl ring
6		51140/S	Tip long life ø 1,10 (replaces W0300125)
		W0300174	51141/S Tip long life ø 1,35 (replaces W0300126)
	○ □	W0300175	51142/S Tip long life ø 1,60 (replaces W0300127)
		W0300128	51144.24 Gouging tip ø 2,4
7		W0300135	51410 Contact tip ø 1,35
		W0300137	51411 Contact tip ø 1,6
8		06005	Extended diffusor
9	W0300133	52549	Extended electrode
10	W0300134	51148	Extended tip (for contact cutting max. 50A)
11	W0300178	51148.13	Extended tip ø 1,35 - 90A - (for 51958 + 51959 or 60380)
	W0300179	51148.16	Extended tip ø 1,6 - 120A - (for 51958 + 51959 or 60380)
12	○	W0300129	60328 Nozzle retaining cap
13	□	W0300138	60348 Contact nozzle retaining cap
		60348/V	Contact nozzle retaining cap, Max.life
14	□	W0300244	51952 Spring holder protection nut
15	W0300245	51911	Spacer spring for code 51952
16		51953	Gouging spacer
17	W0300180	51950	Spacer for contact cutting, hand (for use with item. 6 only)
18		51930	Spacer for contact cutting, hand (for use with item. 7 only)
19	W0300181	51951	Shield cup, machine (for use with item. 6 only)
20		51935	Shield cup, machine (for use with item. 7 only)
21	W0300182	51957	Shield cup, hand (max. 50A)
22	W0300183	51958	Spacer for contact cutting, hand
23		51974	Spacer for extended tips High Amp.
24	W0300184	51959	Locking nut
25	W0300187	60380	Spacer complete with springs
25a	W0300188	60381	Spare springs
26	○	W0300130	51910 Spacer spring
27	W0300131	60370	Double pointed spacer
28	W0300177	60371	Crown spacer
29	W0300132	60373	Gouging spacer
30	W0300142	60369	Extractor for swirl ring
31	○ □	W0300119	60368 Wrench for electrode

Accessories

51851	Circle cutting attachment
51807	Cutting guide

LTE-150H

LTE-150M

Suitable for: **CEBORA® P150 - CP160**

Max Current : 150Amps
 Duty Cycle: 150 Amps - 60%
 Gas: Air
 Gas Pressure: 70 psi (4.5-5.0 bar)
 Gas Flow: 470 scfh (220 lpm)
 Post Flow Time: 90 sec. recommended
 Pilot : Electrode to Tip
 Ignition: HF

EASY FIT
 Patent Pending

ÚJ
 koaxiális kábel

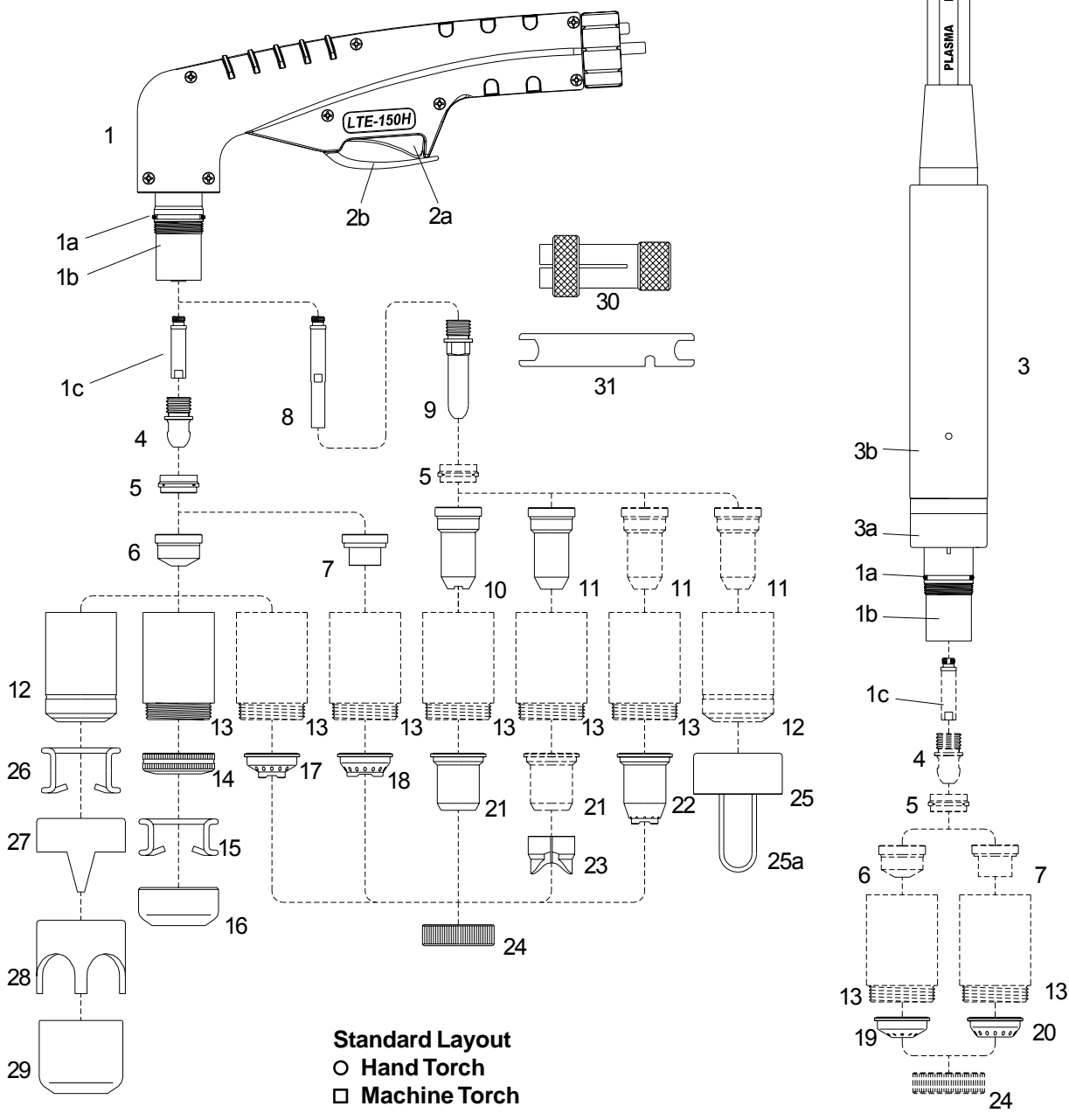
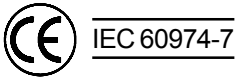

Replacement Parts Suitable for: CEBORA® P150 - CP160

Torch parts

Item#	ref.	Catalog #	Description
1	○	02001E	LTE-105H Hand torch head EASY FIT , w/ handle & parts.
1a	1398	02000.60	O - Ring
1b		60080	Front insulator
1c	1378	05004	Diffusor
2a		07301.20	Switch
2b		09605.42	Safety Tab
3	□	04300E	LTE-150M Machine torch head EASY FIT , w/ positioning tube & parts.
3a		04300	Machine torch head
3b		03310	Positioning Tube
4	○ □	1376	52540 Electrode
5	○ □	1377	60020 Swirl ring
6		1371	51140/S Tip long life ø 1,10
		1372	51141/S Tip long life ø 1,35
		1373	51142/S Tip long life ø 1,60
	○ □	1374	51143/S Tip long life ø 1,80
		1375	51144 Gouging tip ø 3.0
7		51410	Contact tip ø 1,35
		51411	Contact tip ø 1,6
		51412	Contact tip ø 1,8
8		05005	Extended diffusor
9	1517	52549	Extended electrode
10	1369	51148	Extended tip (for contact cutting max. 50A)
11		51148.13	Extended tip ø 1,35 - 90A - (for 51958 + 51959 or 60380)
		51148.16	Extended tip ø 1,6 - 120A - (for 51958 + 51959 or 60380)
		51148.18	Extended tip ø 1,8 - 150A - (for 51958 + 51959 or 60380)
12	○	1389	60330 Nozzle retaining cap
13	□	60350	Contact nozzle retaining cap
		60350/V	Contact nozzle retaining cap, Max.life
14	□	51952	Spring holder protection nut
15		51911	Spacer spring for code 51952
16		51953	Gouging spacer
17		51950	Spacer for contact cutting, hand (for use with item. 6 only)
18		51930	Spacer for contact cutting, hand (for use with item. 7 only)
19		51951	Shield cup, machine (for use with item. 6 only)
20		51935	Shield cup, machine (for use with item. 7 only)
21		51957	Shield cup, hand (max. 50A)
22		51958	Spacer for contact cutting, hand
23		51974	Spacer for extended tips High Amp.
24		51959	Locking nut
25		60380	Spacer complete with springs
25a		60381	Spare springs
26	○	1386	51910 Spacer spring
27		1408	60370 Double pointed spacer
28		60371	Crown spacer
29		1406	60373 Gouging spacer
30		1509	60369 Extractor for swirl ring
31	○ □	3.045.010	60368 Wrench for electrode
Accessories			
		169	51851 Circle cutting attachment
		155	51807 Cutting guide

LTE-81H LTE-81M

Suitable for: TRAFIMET® A80 - Ergocut A81

Max Current : 80 Amps
 Duty Cycle: 80 Amps- 60%
 Gas: Air
 Gas Pressure: 70 psi (4.5-5.0 bar)
 Gas Flow: 340 scfh (160 lpm)
 Post Flow Time: 90 sec. recommended
 Pilot : Electrode to Tip
 Ignition: HF

EASY FIT
 Patent Pending

ÚJ
 koaxiális kábel

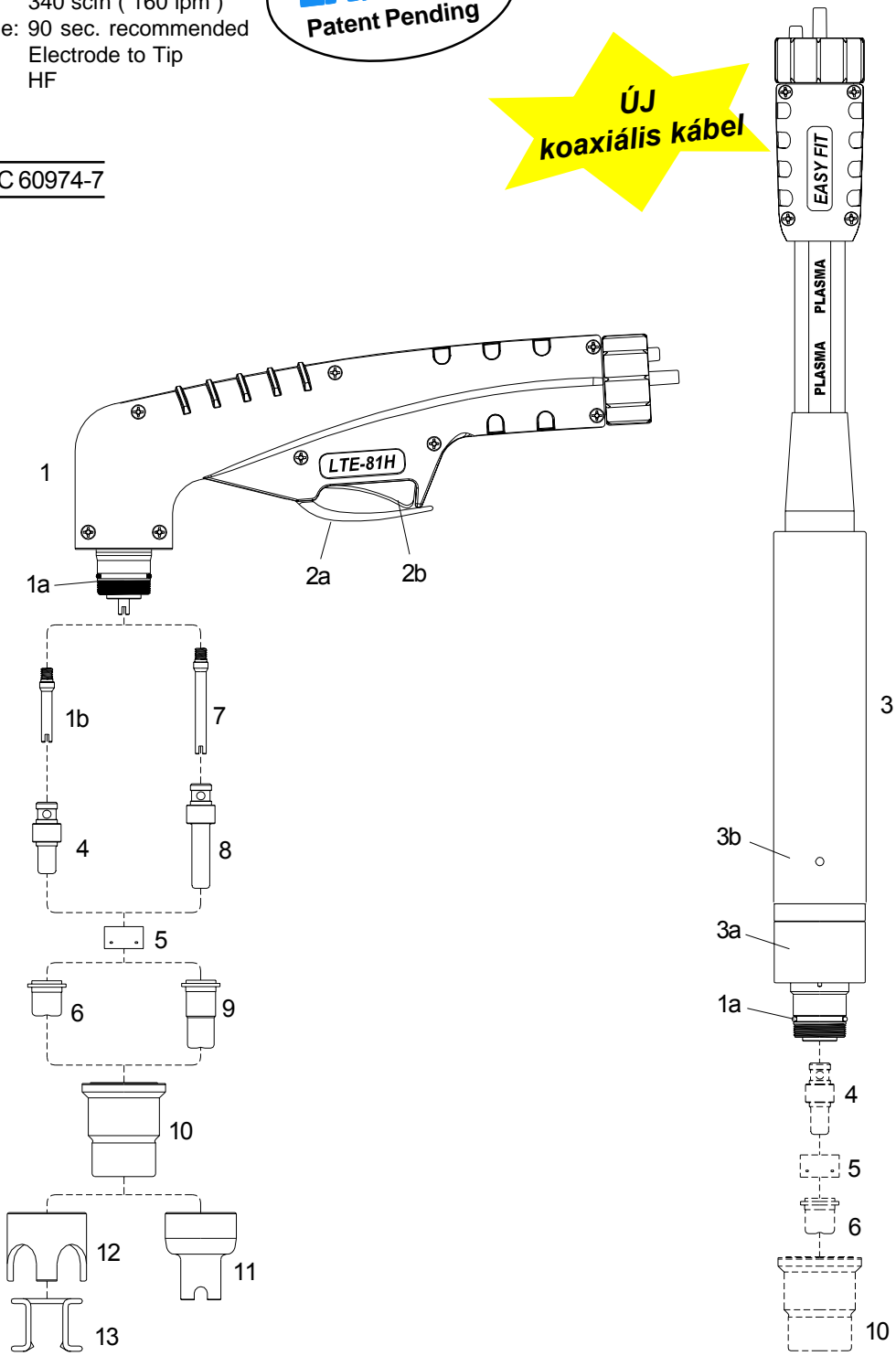
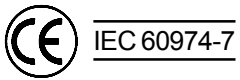

Standard Layout
 ○ Hand Torch
 □ Machine Torch

Replacement Parts Suitable for: TRAFIMET® A80 - Ergocut A81

Torch parts

Item#	ref.	Catalog #	Description
1	○	06802E	LTE-81H Hand torch head EASY FIT , w/ handle & parts.
1a	EA 0125	07300.60	O - Ring
1b	FH 0560	06801.42	Diffusor
2a	BX 0020	07301.20	Switch
2b		09605.42	Safety Tab
3	□	06811E	LTE-81M Machine torch head EASY FIT , w/ positioning tube & parts.
3a		06811	Machine torch head
3b		03310	Positioning Tube
4	○ □	PR 0109	52580/S Electrode - Maximum Life
5	○ □	PE 0107	60029 Swirl ring
6		PD0105-10	51170 Tip 1.0
		PD0105-11	51172 Tip 1.1
	○ □	PD0105-12	51172.12 Tip 1.2
7		FH 0561	06801.43 Extended diffusor
8		PR 0115	52581/S Extended electrode - Maximum Life
9		PD0106-10	51171.10 Extended tip 1.0
		PD0106-12	51173 Extended tip 1.2
10	○ □	PC 0115	60384 Nozzle retaining cap
11		CV 0201	51976 Spacer for contact cutting
12		CV 0033	60378 Crown spacer
13	○	CV 0028	51902 Spacer spring

Accessories

51861	Circle cutting attachment
51817	Cutting guide

LTE-101H

LTE-101M

Suitable for: TRAFIMET® A90 - Ergocut 101

Max Current : 100Amps
 Duty Cycle: 100 Amps - 60%
 Gas: Air
 Gas Pressure: 70 psi (4.5-5.0 bar)
 Gas Flow: 380 scfh (180 lpm)
 Post Flow Time: 90 sec. recommended
 Pilot : Electrode to Tip
 Ignition: HF

EASY FIT
 Patent Pending

ÚJ
 koaxiális kábel

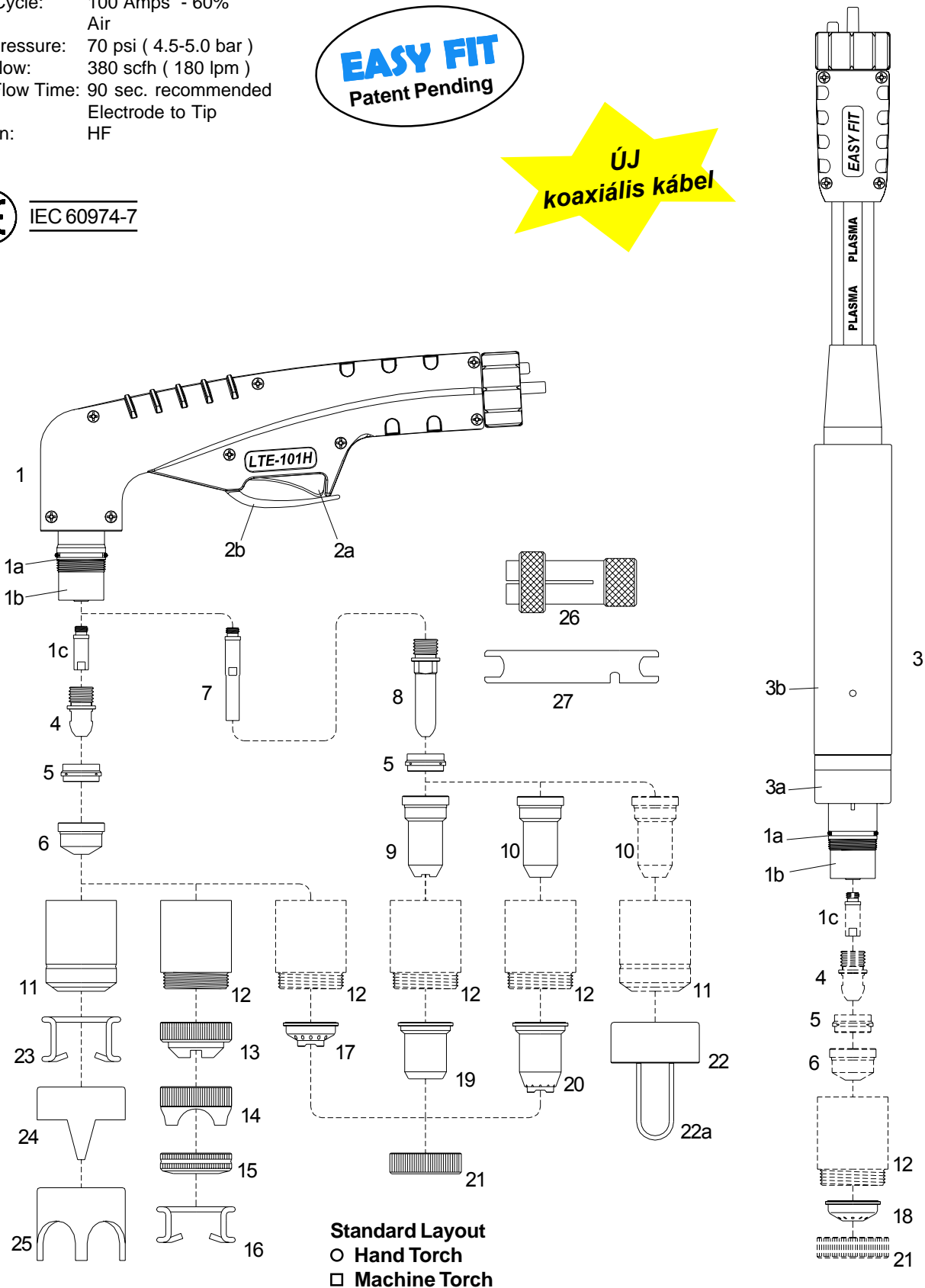
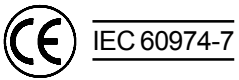

Replacement Parts Suitable for: TRAFIMET® A90 - Ergocut 101

Torch parts

Item#	ref.	Catalog #	Description
1	○	06001E	LTE-101H Hand torch head EASY FIT , w/ handle & parts.
1a	EA 0131	06000.60	O - Ring
1b		60085	Front insulator
1c		06004	Diffusor
2a	BX 0020	07301.20	Switch
2b		09605.42	Safety Tab
3	□	06600E	LTE-101M Machine torch head EASY FIT , w/ positioning tube & parts.
3a		06600	Machine torch head
3b		03310	Positioning Tube
4	○ □	PR 0101	Electrode
5	○ □	PE 0101	Swirl ring
6		PD 0101-11	Tip ø 1.1
		PD 0101-14	Tip ø 1.4
	○ □	PD 0101-17	Tip ø 1.7
7		06005	Extended Diffusor
8		52538	Extended electrode
9		51159	Extended tip (max. 50A)
10		51159.14	Extended tip ø 1.4 - (for 51958 + 51959 or 60380)
		51159.17	Extended tip ø 1.7 - (for 51958 + 51959 or 60380)
11	○	PC 0109/0111	Nozzle retaining cap, long life
12	□	PC 0113/0130	Contact nozzle retaining cap
		PC 0113/0130	Contact nozzle retaining cap, Max.life
13		CV 0023	Spacer for contact cutting
14		CV 0039	Large spacer for contact cutting
15	□	51952	Spring holder protection nut
16		51911	Spacer spring for code 51952
17		51950	Spacer for contact cutting, hand (for use with item. 6 only)
18		51951	Spacer for contact cutting, Machine (for use with item. 6 only)
19		CV 0008	Shield cup, hand (max. 50A) (for use with item. 21 only)
20		CV 0009	Spacer for contact cutting, hand (for use with item. 21 only)
21		51959	Locking nut
22		60380	Spacer complete with springs
22a		60381	Spare springs
23	○	CV 0011	Spacer spring
24		CV 0012	Double pointed spacer
25		CV 0014	Crown spacer
26		GR 60	Extractor for swirl ring
27	○ □	60368	Wrench for electrode

Accessories

51851	Circle cutting attachment
51807	Cutting guide

LTE-141H LTE-141M

Suitable for: TRAFIMET® A140 - Ergocut 141

Max Current : 150Amps
 Duty Cycle: 150 Amps - 60%
 Gas: Air
 Gas Pressure: 70 psi (4.5-5.0 bar)
 Gas Flow: 470 scfh (220 lpm)
 Post Flow Time: 90 sec. recommended
 Pilot : Electrode to Tip
 Ignition: HF

EASY FIT
 Patent Pending

ÚJ
 koaxiális kábel

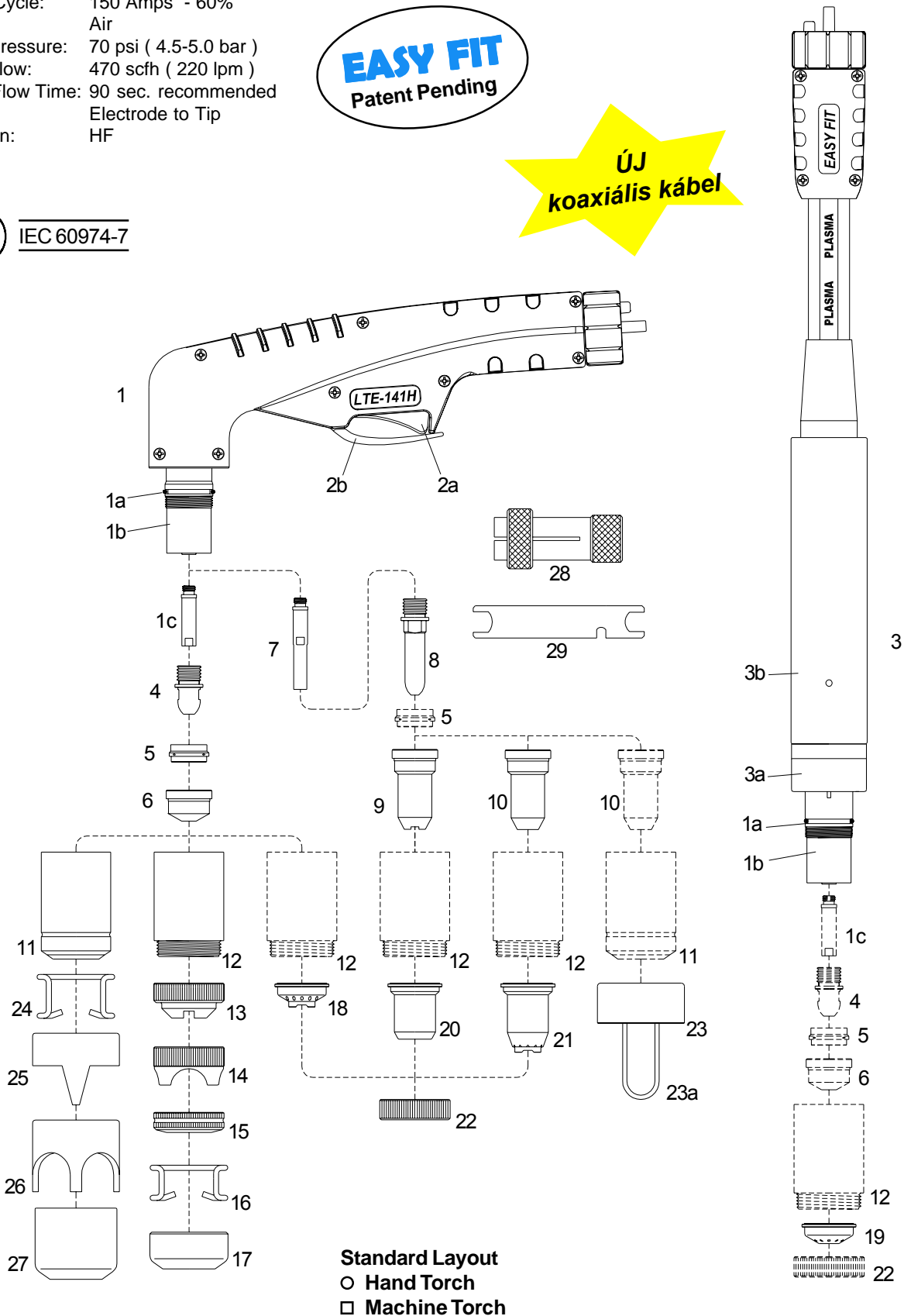

Replacement Parts Suitable for: TRAFIMET® A140 - Ergocut 141

Torch parts

Item#	ref.	Catalog #	Description
1	○	06201E	LTE-141H Hand torch head EASY FIT , w/ handle & parts.
1a	EA 0131	06000.60	O - Ring
1b		60080	Front insulator
1c		05004	Diffusor
2a	BX 0020	07301.20	Switch
2b		09605.42	Safety Tab
3	□	06400E	LTE-141M Machine torch head EASY FIT , w/ positioning tube & parts.
3a		06400	Machine torch head
3b		03310	Positioning Tube
4	○ □	PR 0101	52535 Electrode
5	○ □	PE 0101	60030 Swirl ring
6		PD0101-11	51154 Tip ø 1.1
		PD0101-14	51155 Tip ø 1.4
		PD0101-17	51156 Tip ø 1.7
	○ □	PD0101-19	51157 Tip ø 1.9
		PD0101-30	51158 Gouging tip ø 3.0
7		05005	Extended Diffusor
8		52538	Extended electrode
9		51159	Extended tip (max. 50A)
10		51159.14	Extended tip ø 1.4 - (for 51958 + 51959 or 60380)
		51159.17	Extended tip ø 1.7 - (for 51958 + 51959 or 60380)
		51159.19	Extended tip ø 1.9 - (for 51958 + 51959 or 60380)
11	○	PC0101/0102	60375 Nozzle retaining cap, long life
12	□	PC0103/0131	60385 Contact nozzle retaining cap
		PC0103/0131	60385/V Contact nozzle retaining cap, Max.life
13		CV 0023	51940 Spacer for contact cutting
14		CV 0039	51945 Large spacer for contact cutting
15	□		51952 Spring holder protection nut
16			51911 Spacer spring for code 51952
17			51953 Gouging spacer
18			51950 Spacer for contact cutting, hand (for use with item. 6 only)
19			51951 Spacer for contact cutting, Machine (for use with item. 6 only)
20		CV 0008	51957 Shield cup, hand (max. 50A) (for use with item. 21 only)
21		CV 0009	51958 Spacer for contact cutting, hand (for use with item. 21 only)
22			51959 Locking nut
23			60380 Spacer complete with springs
23a			60381 Spare springs
24	○	CV 0011	51910 Spacer spring
25		CV 0012	60370 Double pointed spacer
26		CV 0014	60371 Crown spacer
27		CV 0013	60373 Gouging spacer
28		GR 60	60369 Extractor for swirl ring
29	○ □		60368 Wrench for electrode

Accessories

51851	Circle cutting attachment
51807	Cutting guide

LTE-151H

LTE-151M

Suitable for: TRAFIMET® R145 - Ergocut A151

Max Current : 150Amps
 Duty Cycle: 150 Amps - 60%
 Gas: Air
 Gas Pressure: 70 psi (4.5-5.0 bar)
 Gas Flow: 470 scfh (220 lpm)
 Post Flow Time: 90 sec. recommended
 Pilot : Electrode to Tip
 Ignition: HF

EASY FIT
 Patent Pending

ÚJ
 koaxiális kábel

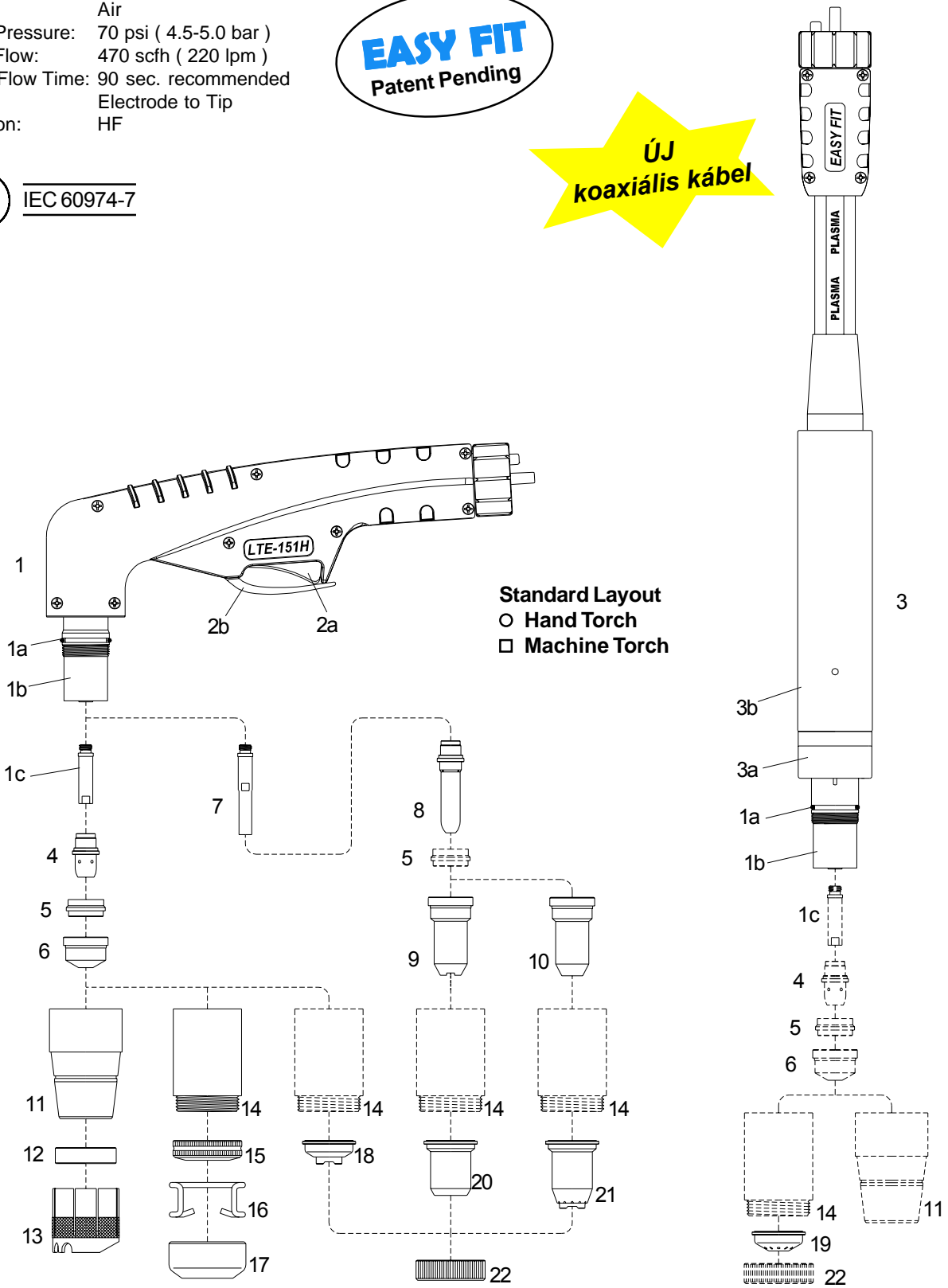

Replacement Parts Suitable for: R145 - Ergocut A151

Torch parts

Item#	ref.	Catalog #	Description
1	○	06901E	LTE-151H Hand torch head EASY FIT , w/ handle & parts.
1a	EA 0131	06000.60	O - Ring
1b		60080	Front insulator
1c		05004	Diffusor
2a	BX 0020	07301.20	Switch
2b		09605.42	Safety Tab
3	□	06910E	LTE-151M Machine torch head EASY FIT , w/ positioning tube & parts.
3a		06910	Machine torch head
3b		03310	Positioning Tube
4	○ □	PR 0111	52534 Electrode
5	○ □	PE 0103	60031 Insulating spacer
6		PD 0109-14	51241 Tip ø 1.4
		PD 0109-16	51242 Tip ø 1.6
	○ □	PD 0109-18	51243 Tip ø 1.8
		PD 0109-30	51244 Gouging tip ø 3.0
7		05005	Extended Diffusor
8	PR 0116	52530	Extended electrode
9	PD 0111	51149	Extended tip ø 1.2 (max 50A)
10	PD 0117-14	51149.14	Extended tip ø 1.4 - (for use with item. 25+26)
	PD 0117-17	51149.17	Extended tip ø 1.7 - (for use with item. 25+26)
	PD 0117-19	51149.19	Extended tip ø 1.9 - (for use with item. 25+26)
11	○	PC 0120	60387 Nozzle retaining cap
12	○	BW 0139	60388 Nozzle shield
13	○	CV 1105	60379 Cage spacer
14	□	PC 0103/0131	60385 Contact nozzle retaining cap
		PC 0103/0131	60385/V Contact nozzle retaining cap, Max.life
15	□		51952 Spring holder protection nut
16			51911 Spacer spring for code 51952
17			51953 Gouging spacer
18			51950 Spacer for contact cutting, hand (for use with item. 6 only)
19			51951 Spacer for contact cutting, Machine (for use with item. 6 only)
20	CV 0008	51957	Shield cup, hand (tip max. 50A) (for use with item. 26 only)
21	CV 0009	51958	Spacer for contact cutting, hand (for use with item. 26 only)
22		51959	Locking nut

Accessories

51851	Circle cutting attachment
51807	Cutting guide